



DATE: 9 August 2016

**I.T.L. (PRODUCT TESTING) LTD.
FCC/IC Radio Test Report
for
Pointer Telocation**

**Equipment under test:
Self Powered Smart Hub**

CelloTrack Nano 20 P/N GC9770001-000

Tested by:

M. Zohar

Approved by:

D. Shidlowsky

This report must not be reproduced, except in full, without the written permission of I.T.L. (Product Testing) Ltd.

This report relates only to items tested.



Measurement/Technical Report for Pointer Telocation

Self Powered Smart Hub

CelloTrack Nano 20 P/N GC9770001-000

FCC ID: 2AG69NANO2G

IC: 9975A-NANO2G

This report concerns:	Original Grant: X
	Class I Change:
	Class II Change:
Equipment type:	Digital Transmission System IC: Spread Spectrum Digital Device (2400-2483.5)
Limits used:	47CFR15 Section 15.247 RSS-247, Issue 1, May 2015 RSS Gen, Issue 4, November 2014

Measurement procedure used is KDB 558074 D01 v03r03 and ANSI C63.10:2013.

Application for Certification
prepared by:
R. Pinchuck
ITL (Product Testing) Ltd.
1 Bat Sheva St.
Lod 7116002
e-mail Rpinchuck@itl.co.il

Applicant for this device:
(different from "prepared by")
Igor Rogov
Pointer Telocation
14 Hamelacha St.
Rosh Ha'ayin , 48091, Israel
Tel:: +972-73-262-2320
Fax: +972-3-572-3100
e-mail: Igorr@pointer.com



TABLE OF CONTENTS

1.	GENERAL INFORMATION	5
1.1	Administrative Information	5
1.2	List of Accreditations	6
1.3	Product Description	7
1.4	Test Methodology	7
1.5	Test Facility	7
1.6	Measurement Uncertainty	7
2.	SYSTEM TEST CONFIGURATION	8
2.1	Justification	8
2.2	EUT Exercise Software	8
2.3	Special Accessories	8
2.4	Equipment Modifications	8
2.5	Configuration of Tested System	9
3.	CONDUCTED & RADIATED MEASUREMENT TEST SET-UP PHOTOS	10
4.	CONDUCTED EMISSION FROM AC MAINS	13
4.1	Test Specification	13
4.2	Test Procedure	13
4.3	Test Results	14
4.4	Test Equipment Used; Conducted Emission	19
5.	6 DB MINIMUM BANDWIDTH	20
5.1	Test Specification	20
5.2	Test Procedure	20
5.3	Test Results	20
5.4	Test Equipment Used; 6dB Bandwidth	23
6.	MAXIMUM TRANSMITTED PEAK POWER OUTPUT	24
6.1	Test Specification	24
6.2	Test Procedure	24
6.3	Test Results	24
6.4	Test Equipment Used; Maximum Peak Power Output	27
7.	BAND EDGE SPECTRUM	28
7.1	Test Specification	28
7.2	Test Procedure	28
7.3	Test Results	28
7.4	Test Equipment Used; Band Edge Spectrum	30
8.	EMISSIONS IN NON-RESTRICTED FREQUENCY BANDS	31
8.1	Test Specification	31
8.2	Test Procedure	31
8.3	Test Results	31
8.4	Test Instrumentation Used, Emission in Non Restricted Frequency Bands	33
9.	EMISSIONS IN RESTRICTED FREQUENCY BANDS	34
9.1	Test Specification	34
9.2	Test Procedure	34
9.3	Test Results	35
9.4	Test Instrumentation Used; Emissions in Restricted Frequency Bands	38
10.	TRANSMITTED POWER DENSITY	39
10.1	Test Specification	39
10.2	Test Procedure	39
10.3	Test Results	39
10.4	Test Equipment Used; Transmitted Power Density	42
11.	INTERMODULATION RADIATED SPURIOUS EMISSIONS	43
11.1	Test Procedure	43
11.2	Test Results	45
11.3	Test Instrumentation Used; Radiated Measurements Intermodulation	46



12. ANTENNA GAIN/INFORMATION	47
13. APPENDIX A - CORRECTION FACTORS	48
13.1 Correction factors for CABLE from EMI receiver	48
13.2 Correction factor for RF CABLE for Semi Anechoic Chamber	49
13.3 Correction factors for Low Loss CABLE	50
13.4 Correction factors for Horn Antenna	51
13.5 Correction factors for Horn ANTENNA	52
13.6 Correction factors for Log Periodic Antenna	53
13.7 Correction factors for ACTIVE LOOP ANTENNA	54
13.8 Correction factors for Biconical Antenna	55



1. General Information

1.1 Administrative Information

Manufacturer:	Pointer Telocation
Manufacturer's Address:	14 Hamelacha St., Rosh Ha'ayin, 48091 Israel Tel: +972-73-262-2320 Fax: +972-3-572-3100
Manufacturer's Representative:	Igor Rogov
Equipment Under Test (E.U.T):	Self Powered Smart Hub
Product Marketing Name (PMN):	CelloTrack Nano 20 P/N GC9770001-000
Equipment Serial No.:	Not designated
HVIN:	A
Date of Receipt of E.U.T:	20.12.2015
Start of Test:	21.12.2015
End of Test:	24.12.2015
Test Laboratory Location:	I.T.L (Product Testing) Ltd. 1 Batsheva St., Lod ISRAEL 7120101
Test Specifications:	FCC Part 15, Subpart C RSS-247, Issue 1, May 2015 RSS Gen Issue 4, November 2014



1.2 **List of Accreditations**

The EMC laboratory of I.T.L. is accredited by the following bodies:

1. The American Association for Laboratory Accreditation (A2LA) (U.S.A.), Certificate No. 1152.01.
2. The Federal Communications Commission (FCC) (U.S.A.), FCC Designation No. IL1005.
3. The Israel Ministry of the Environment (Israel), Registration No. 1104/01.
4. The Voluntary Control Council for Interference by Information Technology Equipment (VCCI) (Japan), Registration Numbers: C-3006, R-2729, T-1877, G-245.
5. Industry Canada (Canada), IC File No.: 46405-4025; Site Nos. IC 4025A-1, IC 4025A-2.

I.T.L. Product Testing Ltd. is accredited by the American Association for Laboratory Accreditation (A2LA) and the results shown in this test report have been determined in accordance with I.T.L.'s terms of accreditation unless stated otherwise in the report.



1.3 Product Description

Self-powered Smart hub for Asset & Cargo Management IoT applications supporting 2G cellular communication, GNSS, short range RF and wide sensing capabilities.

The E.U.T. contains a Cinterion BGS2 Wireless 2G module (FCC ID: QIPBGS2, IC: 7830A-BGS2).

Model name	CelloTrack Nano 20 P/N GC9770001-000
Working voltage	AC/DC adapter
Mode of operation	Transceiver BLE
Modulations	GFSK
Assigned Frequency Range	2400.0MHz-2483.5MHz
Operating Frequency Range	2402.0MHz-2480.0MHz
Transmit power	~8.0dBm
Antenna Gain	1.7 dBi
Modulation BW	>500kHz
Temperature (°C)/ Humidity (%RH)	21°C /44.1%

1.4 Test Methodology

Both conducted and radiated testing was performed according to the procedures in KDB 558074 D01 v03r03 and ANSI C63.10: 2013. Radiated testing was performed at an antenna to EUT distance of 3 meters.

1.5 Test Facility

Emissions tests were performed at I.T.L.'s testing facility in Lod, Israel. I.T.L.'s EMC Laboratory is accredited by A2LA, certificate No. 1152.01 and its FCC Designation Number is IL1005.

1.6 Measurement Uncertainty

Conducted Emission Power Lines (CISPR 11, EN 55011, CISPR 22, EN 55022, ANSI C63.4)

0.15 – 30 MHz:

Expanded Uncertainty (95% Confidence, K=2):

± 3.44 dB

Radiated Emission

Radiated Emission (CISPR 11, EN 55011, CISPR 22, EN 55022, ANSI C63.4) for open site 30-1000MHz:

Expanded Uncertainty (95% Confidence, K=2):

± 4.98 dB

2. System Test Configuration

2.1 Justification

Conducted emission tests were performed with the E.U.T. antenna terminal connected by a RF cable to the Spectrum Analyzer through a 20dB external attenuator.

For radiated emission tests, exploratory emission testing was performed in 3 orthogonal polarities to determine the worst case regarding spurious emission in the restricted band section.

The results are shown in the below tables:

Frequency	Y axis	X axis	Z axis
(MHz)	fundamental	fundamental	fundamental
2402.0	64.1	64.2	46.5
2440.0	62.4	62.9	58.2
2480.0	61.2	64.2	56.0

Frequency (MHz)	Y axis			X axis			Z axis		
	H2	H3	Band edge	H2	H3	Band edge	H2	H3	Band edge
2402.0	30.7	34.5	22.9	33.3	35.0	23.5	33.0	34.0	23.2
2440.0	33.5	38.1	-	33.7	38.6	-	33.5	38.4	-
2480.0	33.6	37.9	22.1	34.0	38.3	23.1	33.8	38.1	22.4

Figure 1. Screening Results

According to above results the worst case was the X axis.

The unit was evaluated while transmitting at the low channel (2402MHz), the mid channel (2440MHz) and the high channel (2480MHz) in BLE technology.

2.2 EUT Exercise Software

No special exercise software was used.

2.3 Special Accessories

No special accessories were needed to achieve compliance.

2.4 Equipment Modifications

No modifications were necessary in order to achieve compliance.

2.5 Configuration of Tested System

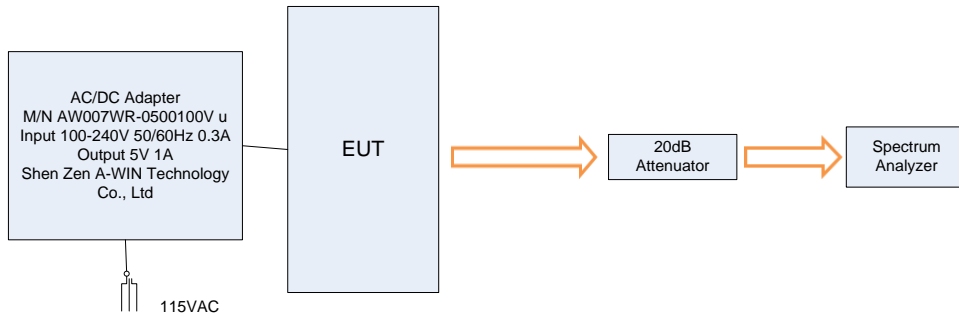

Figure 2. Configuration of Tested System Conducted

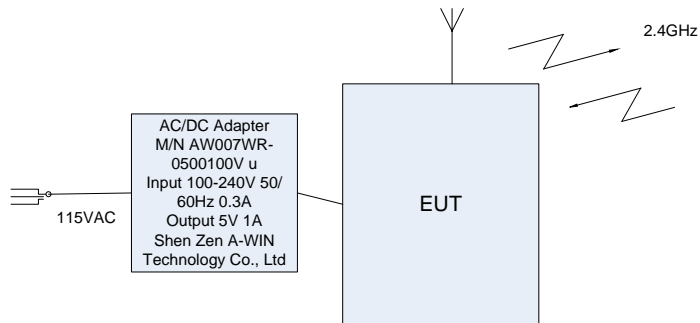

Figure 3. Configuration of Tested System Radiated

3. Conducted & Radiated Measurement Test Set-Up Photos



Figure 4. Conducted Emission from AC Mains Test

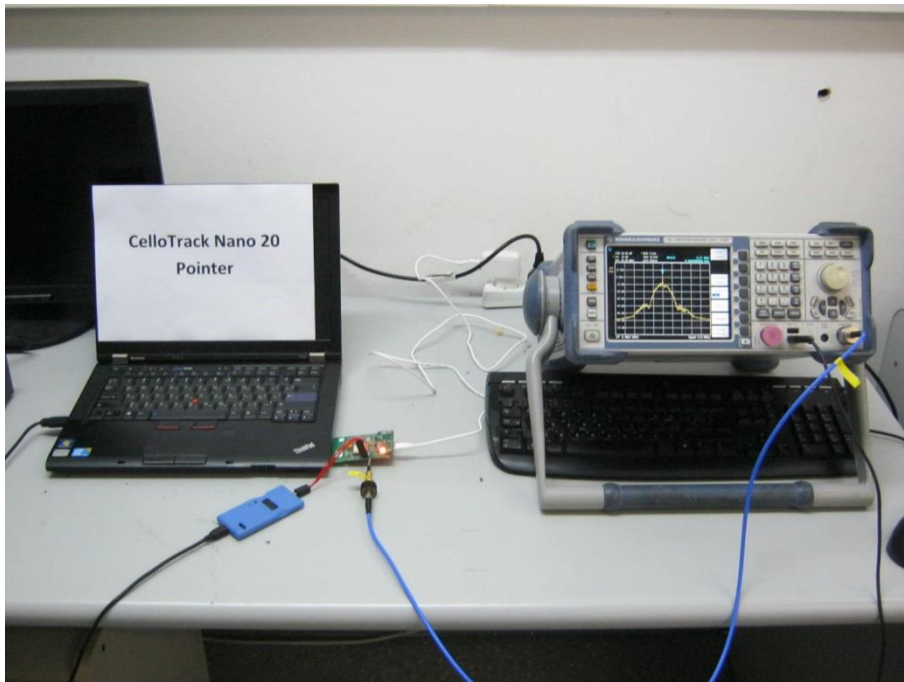

Figure 5. Conducted Emission From Antenna Ports Test



Figure 6. Radiated Emission Test

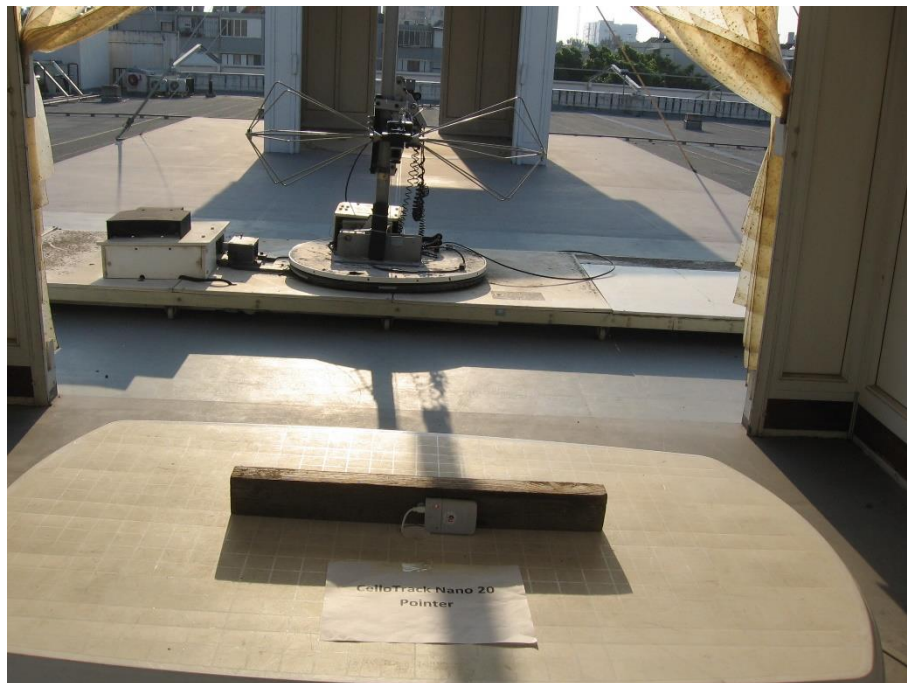

Figure 7. Radiated Emission Test

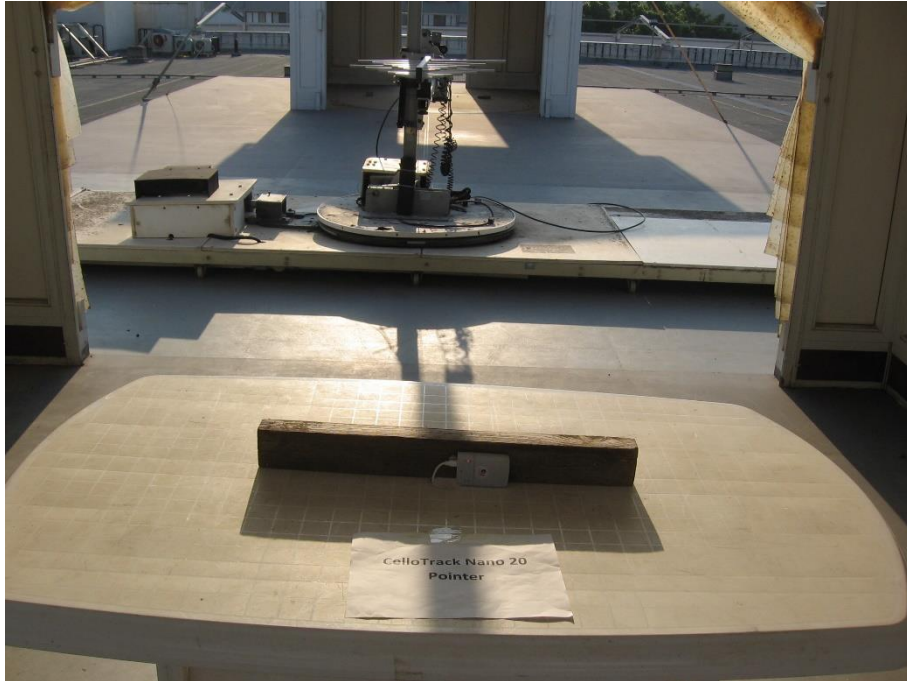

Figure 8. Radiated Emission Test

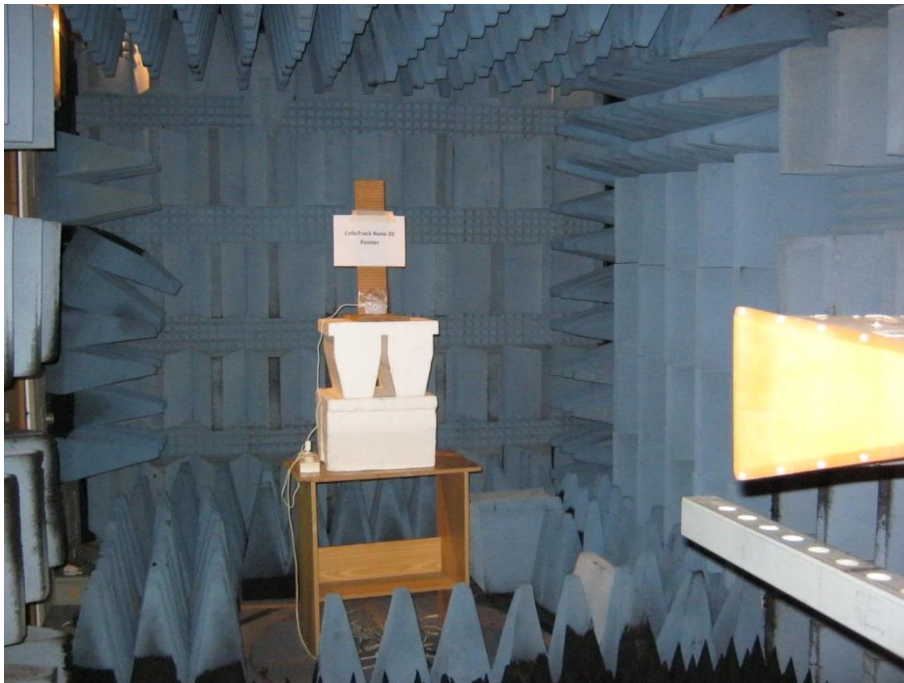

Figure 9. Radiated Emission Test

4. Conducted Emission From AC Mains

4.1 Test Specification

FCC Part 15, Subpart C, Section 15.207
RSS Gen, Issue 4, Clause 8.8

4.2 Test Procedure

The E.U.T operation mode and test setup are as described in Section 2 of this report. In order to minimize background noise interference, the conducted emission testing was performed inside a shielded room, with the E.U.T placed on a 0.8 meter high wooden table, 0.4 meter from the room's vertical wall. In the case of a floor-standing E.U.T., it was placed on the horizontal ground plane.

The E.U.T was powered from 115 V AC / 60 Hz via 50 Ohm / 50 μ Hn Line Impedance Stabilization Network (LISN) on the phase and neutral lines. The LISN's were grounded to the shielded room ground plane (floor), and were kept at least 0.8 meters from the nearest boundary of the E.U.T

The center of the E.U.T.'s AC cable was folded back and forth, in order to form a bundle less than 0.40 meters and a total cable length of 1 meter.

The effect of varying the position of the cables was investigated to find the configuration that produces maximum emission. The configuration tested is shown in the photograph, *Figure 4. Conducted Emission from AC Mains Test.*

The emission voltages at the LISN's outputs were measured using a computerized receiver, complying with CISPR 16 requirements. The specification limits are loaded to the receiver and are displayed on the receiver's spectrum display.

The E.U.T was evaluated in TX operation mode

A frequency scan between 0.15 and 30 MHz was performed at 9 kHz I.F. band width, using peak detection.

The spectral components having the highest level on each line were measured using a quasi-peak and average detector.



4.3 **Test Results**

JUDGEMENT: Passed by 12.79 dB

The margin between the emission levels and the specification limit is, in the worst case, 14.93 dB for the phase line at 0.490 MHz and 12.79 dB at 0.486 MHz for the neutral line.

The EUT met the F.C.C. Part 15, Subpart C specification requirements.

The details of the highest emissions are given in *Figure 10* to *Figure 13*.



Conducted Emission

E.U.T Description Self Powered Smart Hub
Type CelloTrack Nano 20 P/N
 GC9770001-000
Serial Number: Not designated

Specification: FCC Part 15, Subpart C
Lead: Phase
Detectors: : Peak, Quasi-peak, Average
Power Operation AC/DC adapter

EDIT PEAK LIST (Final Measurement Results)				
Trace1:	CE22BQP			
Trace2:	CE22BAP			
Trace3:	---			
	TRACE	FREQUENCY	LEVEL dBµV	DELTA LIMIT dB
1	Quasi Peak	186 kHz	41.58	-22.62
2	Average	194 kHz	25.57	-28.28
1	Quasi Peak	406 kHz	35.74	-21.99
2	Average	406 kHz	20.76	-26.96
2	Average	482 kHz	25.49	-20.80
1	Quasi Peak	490 kHz	41.23	-14.93
2	Average	770 kHz	21.70	-24.29
1	Quasi Peak	798 kHz	34.31	-21.68
2	Average	1.422 MHz	20.60	-25.40
1	Quasi Peak	1.774 MHz	30.51	-25.48
2	Average	2.146 MHz	19.96	-26.03
1	Quasi Peak	2.15 MHz	29.80	-26.20
2	Average	4.078 MHz	16.94	-29.05
1	Quasi Peak	4.15 MHz	27.70	-28.29
2	Average	6.27 MHz	13.49	-36.50
1	Quasi Peak	6.766 MHz	23.57	-36.42
1	Quasi Peak	16.758 MHz	23.86	-36.13
2	Average	17.638 MHz	13.02	-36.97
1	Quasi Peak	18.222 MHz	22.16	-37.83
2	Average	21.706 MHz	17.51	-32.49

Date: 24.DEC.2015 11:21:33

Figure 10. Detectors: Peak, Quasi-peak, Average

Note: QP Delta/Av Delta refers to the test results obtained minus specified requirement; thus a positive number indicates failure, and a negative result indicates that the product passes the test.



Conducted Emission

E.U.T Description Self Powered Smart Hub
Type CelloTrack Nano 20 P/N
 GC9770001-000
Serial Number: Not designated

Specification: FCC Part 15, Subpart C
Lead: Phase
Detectors: Peak, Quasi-peak, Average
Power Operation AC/DC adapter

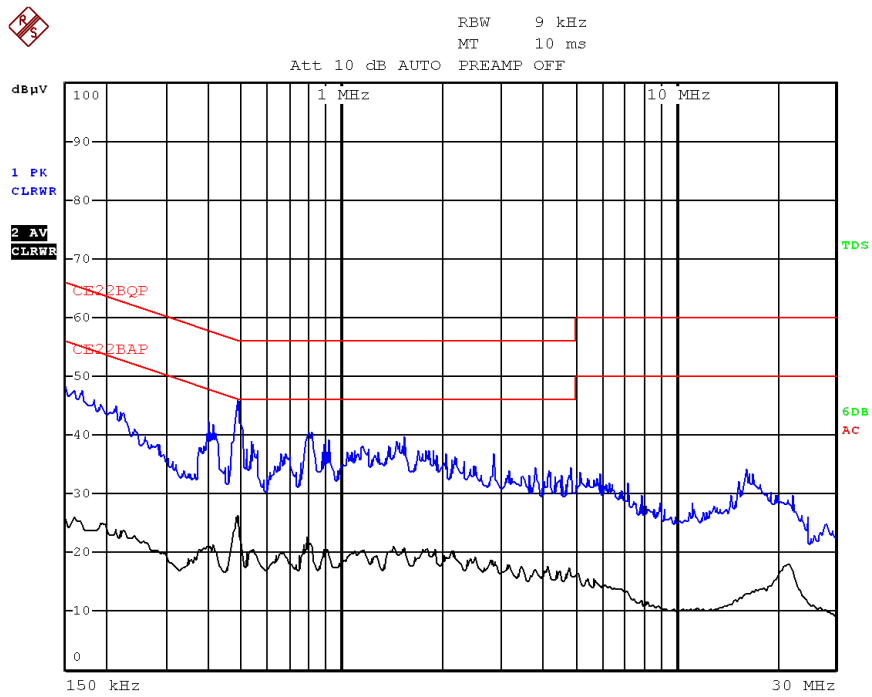

Date: 24.DEC.2015 11:24:40

Figure 11. Detectors: Peak, Quasi-peak, Average



Conducted Emission

E.U.T Description Self Powered Smart Hub
Type CelloTrack Nano 20 P/N
 GC9770001-000
Serial Number: Not designated

Specification: FCC Part 15, Subpart C
Lead: Neutral
Detectors: Peak, Quasi-peak, Average
Power Operation AC/DC adapter

EDIT PEAK LIST (Final Measurement Results)				
TRACE		FREQUENCY	LEVEL dBµV	DELTA LIMIT dB
Trace1:	CE22BQP			
Trace2:	CE22BAP			
Trace3:	---			
1	Quasi Peak	166 kHz	43.89	-21.25
2	Average	190 kHz	25.69	-28.34
1	Quasi Peak	398 kHz	31.94	-25.94
2	Average	410 kHz	26.97	-20.67
1	Quasi Peak	486 kHz	38.89	-17.34
2	Average	486 kHz	33.44	-12.79
2	Average	790 kHz	23.47	-22.52
1	Quasi Peak	810 kHz	29.64	-26.35
2	Average	1.434 MHz	18.47	-27.52
1	Quasi Peak	1.546 MHz	24.80	-31.20
2	Average	2.162 MHz	16.24	-29.75
1	Quasi Peak	2.846 MHz	24.52	-31.48
1	Quasi Peak	3.782 MHz	23.81	-32.18
2	Average	4.142 MHz	15.96	-30.03
2	Average	6.13 MHz	12.82	-37.17
1	Quasi Peak	7.134 MHz	19.20	-40.79
1	Quasi Peak	16.302 MHz	20.28	-39.71
2	Average	17.378 MHz	11.42	-38.57
1	Quasi Peak	17.798 MHz	20.58	-39.41
2	Average	21.898 MHz	15.23	-34.76

Date: 24.DEC.2015 11:38:56

Figure 12. Detectors: Peak, Quasi-peak, Average

Note: QP Delta/Av Delta refers to the test results obtained minus specified requirement; thus a positive number indicates failure, and a negative result indicates that the product passes the test.



Conducted Emission

E.U.T Description Self Powered Smart Hub
Type CelloTrack Nano 20 P/N
 GC9770001-000
Serial Number: Not designated

Specification: FCC Part 15, Subpart C
Lead: Neutral
Detectors: Peak, Quasi-peak, Average
Power Operation AC/DC adapter

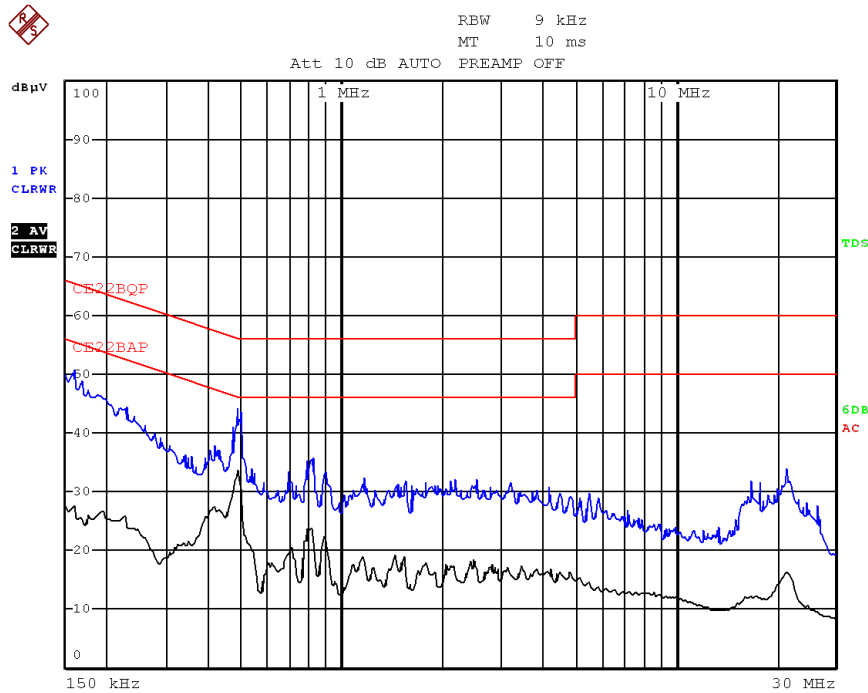

Date: 24.DEC.2015 11:36:04

Figure 13 Detectors: Peak, Quasi-peak, Average



4.4 *Test Equipment Used; Conducted Emission*

Instrument	Manufacturer	Model	Serial No.	Last Calibration Date	Next Calibration Due
LISN	Fischer	FCC-LISN-25A	127	March 16, 2015	March 16, 2016
Transient Limiter	HP	11947A	3107A03041	May 13, 2015	May 30, 2016
EMI Receiver	Rohde & Schwarz	ESCI7	100724	January 4, 2015	January 31, 2016
Low Loss Cable	Huber Suner		705A009301 EIM	May 31, 2015	May 31, 2016

Figure 14 Test Equipment Used

5. 6 dB Minimum Bandwidth

5.1 Test Specification

FCC Part 15, Subpart C, Section 247(a)(2)
RSS GEN 2014, Section 6.6

5.2 Test Procedure

The E.U.T operation mode and test set-up are as described in Section 2 of this report.

The E.U.T. antenna terminal was connected to the Spectrum Analyzer through an external attenuator and an appropriate coaxial cable (loss=20.5 dB). Special attention was taken to prevent Spectrum Analyzer RF input overload.

The spectrum bandwidth of the E.U.T. at the point of 6 dB below maximum peak power was measured and recorded. The RBW was set to 100 kHz.

5.3 Test Results

Operation Frequency (MHz)	Reading (MHz)	Specification (MHz)
2402.0	0.699	>0.5
2440.0	0.679	>0.5
2480.0	0.699	>0.5

Figure 15 6 dB Minimum Bandwidth

JUDGEMENT: Passed

For additional information see *Figure 16 to Figure 18*.

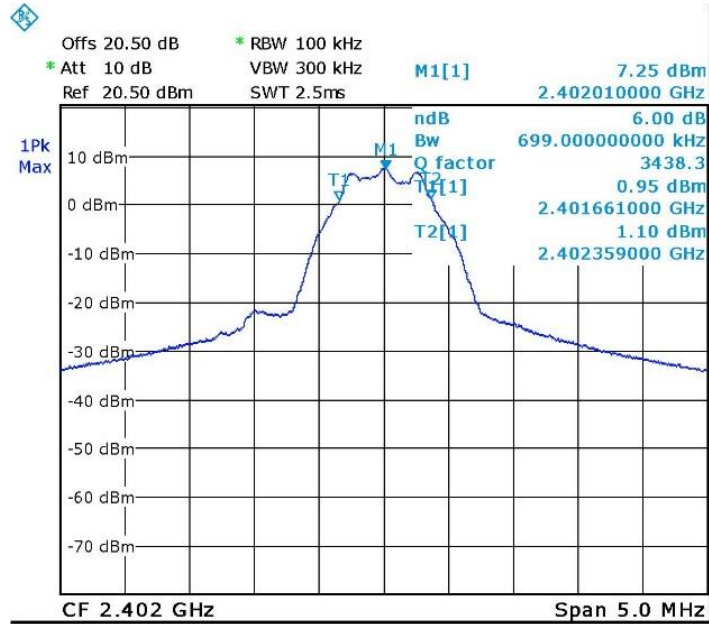

Date: 21.DEC.2015 13:45:04

Figure 16. 2402.0 MHz

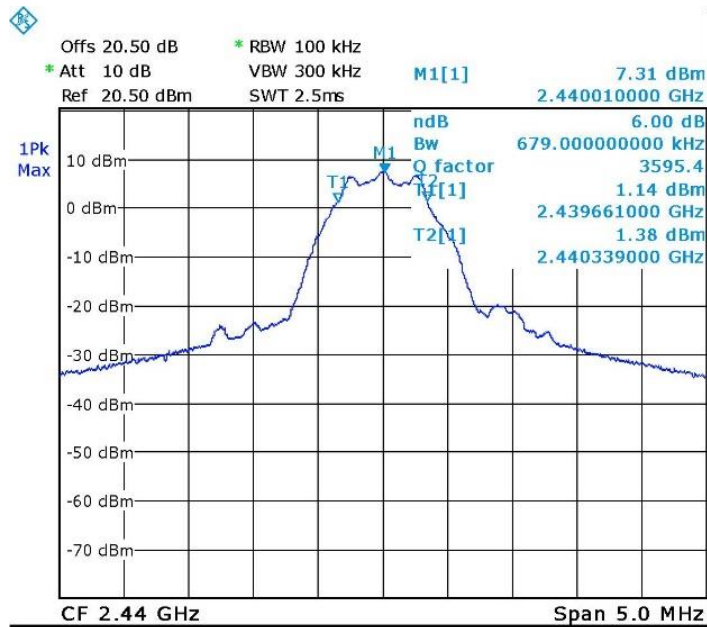

Date: 21.DEC.2015 13:45:49

Figure 17. 2440.0 MHz

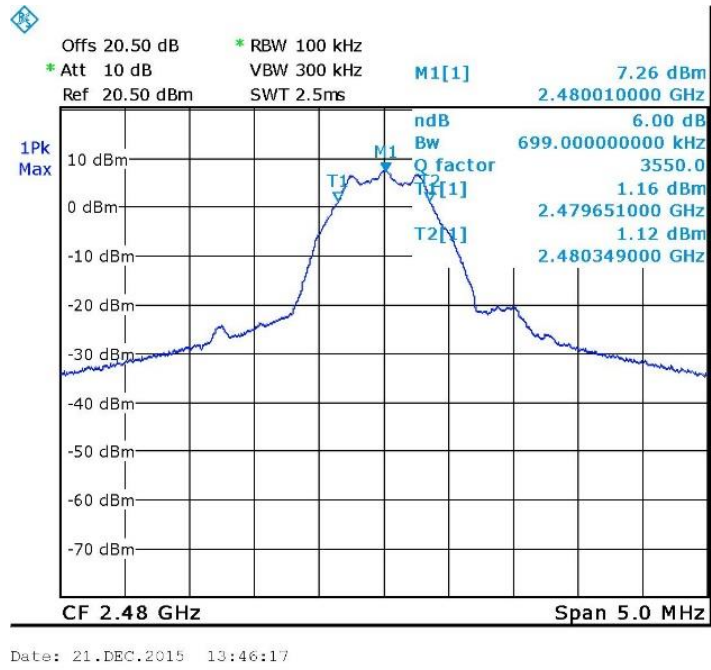

Figure 18. 2480.0 MHz



5.4 Test Equipment Used; 6dB Bandwidth

Instrument	Manufacturer	Model	Serial No.	Last Calibration Date	Next Calibration Due
Spectrum Analyzer	R&S	FSL6	100194	January 1, 2015	January 31, 2016
20 dB Attenuator	MCL	VAT-20W2+	848	June 15, 2015	June 30, 2016

Figure 19 Test Equipment Used

6. Maximum Transmitted Peak Power Output

6.1 Test Specification

FCC, Part 15, Subpart C, Section 247(b)(3)
RSS-247, Issue 1, May 2015, Section 5.4.4

6.2 Test Procedure

The E.U.T operation mode and test set-up are as described in Section 2 of this report.

The E.U.T. antenna terminal was connected to the Spectrum Analyzer through an external attenuator and an appropriate coaxial cable (loss=20.5 dB). Special attention was taken to prevent Spectrum Analyzer RF input overload.

The E.U.T was evaluated in 3 channels: Low (2402.0 MHz), Mid (2440.0 MHz) and High (2480 MHz).

6.3 Test Results

Operation Frequency (MHz)	Power (dBm)	Power (mW)	Specification (mW)	Margin (mW)
2402.0	7.4	5.5	1000.0	-994.5
2440.0	7.4	5.5	1000.0	-994.5
2480.0	7.4	5.5	1000.0	-994.5

Figure 20 Maximum Peak Power Output

JUDGEMENT: Passed by 994.5 mW

For additional information see *Figure 21* to *Figure 23*.

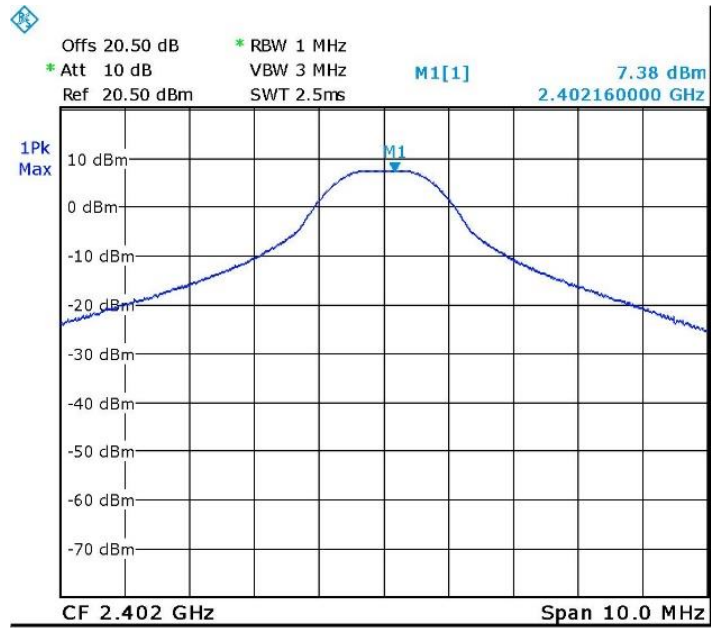

Date: 21.DEC.2015 13:50:23

Figure 21 2402.0 MHz

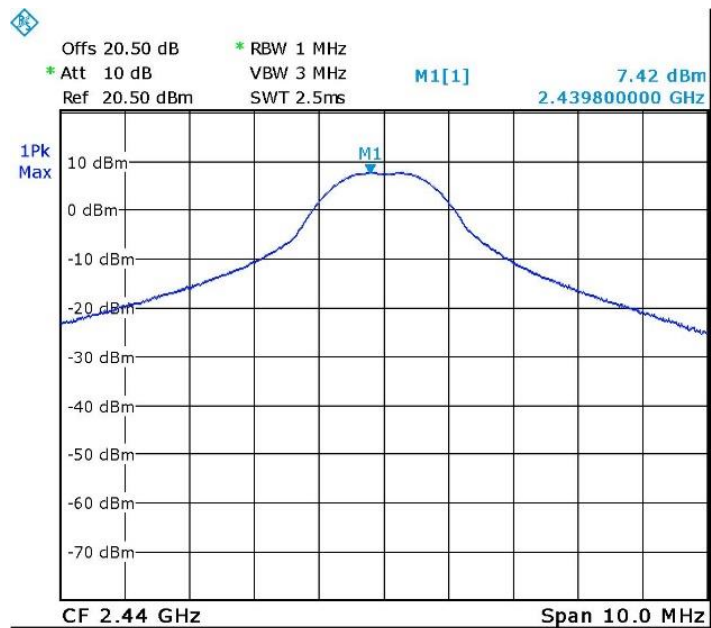

Date: 21.DEC.2015 13:49:21

Figure 22 2440.0 MHz

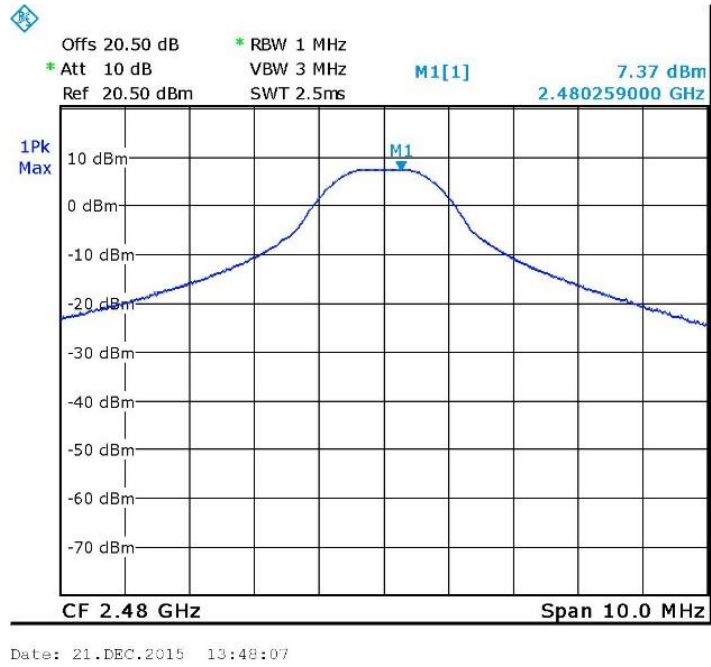

Figure 23 2480.0 MHz



6.4 *Test Equipment Used; Maximum Peak Power Output*

Instrument	Manufacturer	Model	Serial No.	Last Calibration Date	Next Calibration Due
Spectrum Analyzer	R&S	FSL6	100194	January 1, 2015	January 31, 2016
20 dB Attenuator	MCL	VAT-20W2+	848	June 15, 2015	June 30, 2016

Figure 24 Test Equipment Used

7. Band Edge Spectrum

7.1 Test Specification

FCC, Part 15, Subpart C, Section 247(d)
RSS-247, Issue 1, May 2015, Section 5.5

7.2 Test Procedure

The E.U.T operation mode and test set-up are as described in Section 2.
The E.U.T. antenna terminal was connected to the Spectrum Analyzer through an external attenuator and an appropriate coaxial cable (loss=20.5 dB). Special attention was taken to prevent Spectrum Analyzer RF input overload.
The RBW was set to 100 kHz.

7.3 Test Results

Operation Frequency (MHz)	Modulation	Band Edge Frequency (MHz)	Spectrum Level (dBm)	Specification (dBm)	Margin (dB)
Low	BLE	2400.0	-31.3	-12.7	-18.6
High	BLE	2483.5	-38.0	-12.7	-25.3

Figure 25 Band Edge Spectrum

JUDGEMENT: Passed by 18.6 dB

For additional information see *Figure 26* and *Figure 27*.

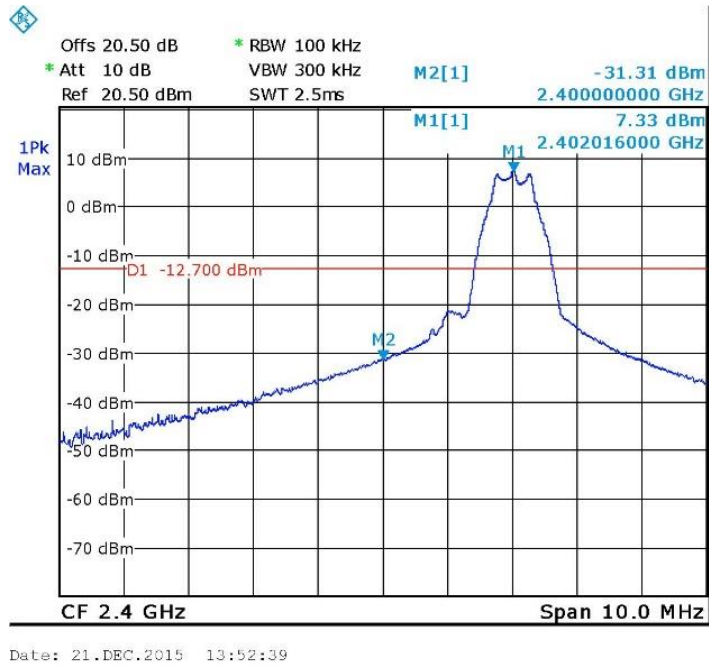

Figure 26 —Lower Band Edge

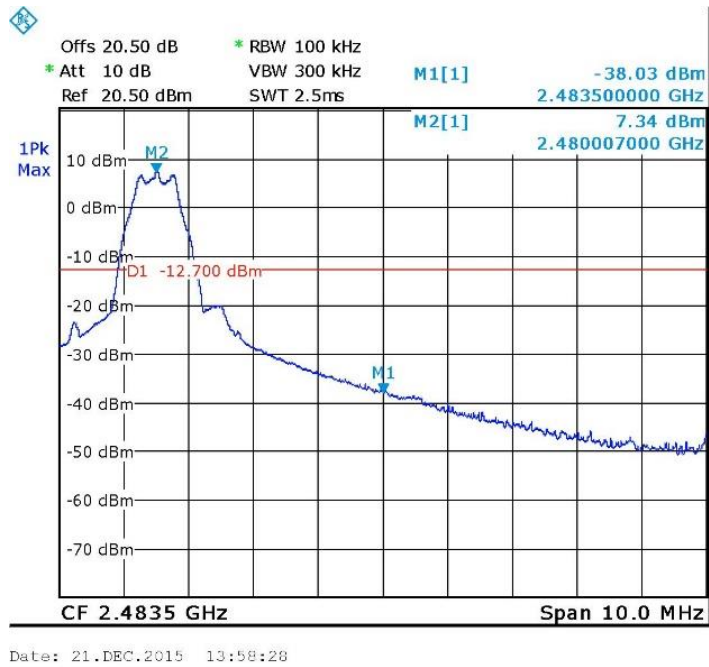

Figure 27 —Upper Band Edge



7.4 *Test Equipment Used; Band Edge Spectrum*

Instrument	Manufacturer	Model	Serial No.	Last Calibration Date	Next Calibration Due
Spectrum Analyzer	R&S	FSL6	100194	January 1, 2015	January 31, 2016
20 dB Attenuator	MCL	VAT-20W2+	848	June 15, 2015	June 30, 2016

Figure 28 Test Equipment Used



8. Emissions in Non-Restricted Frequency Bands

8.1 Test Specification

FCC, Part 15, Subpart C, Section 247(d)
RSS 247 Issue 1 May 2015, Clause 5.5

8.2 Test Procedure

The E.U.T operation mode and test set-up are as described in Section 2.
The E.U.T. antenna terminal was connected to the Spectrum Analyzer through an external attenuator and an appropriate coaxial cable (max total loss=33.0 dB). Special attention was taken to prevent Spectrum Analyzer RF input overload. The E.U.T. was evaluated at the low, mid and high channels (2402.0 MHz, 2440 MHz and 2480.0 MHz).

In any 100 kHz bandwidth outside the frequency band in which the spread spectrum or digitally modulated intentional radiator is operating, the radio frequency power that is produced by the intentional radiator shall be at least 20 dB below that in the 100 kHz bandwidth within the band that contains the highest level of the desired power, based on either an RF conducted or a radiated measurement.

8.3 Test Results

JUDGEMENT: Passed

All detected emissions were greater than 20dBc from fundamental level.

The EUT met the requirements of the F.C.C. Part 15, Subpart C, Section 247(d) and RSS 247 Issue 1 May 2015, Clause 5.5 specification.

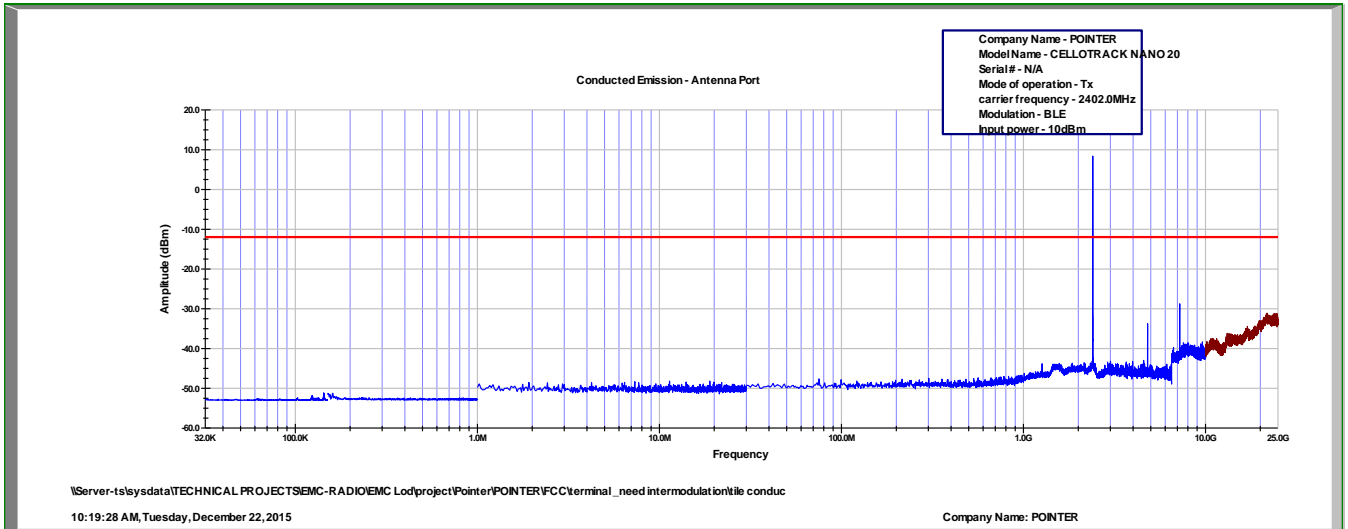

Figure 29 Fundamental 2402.0MHz

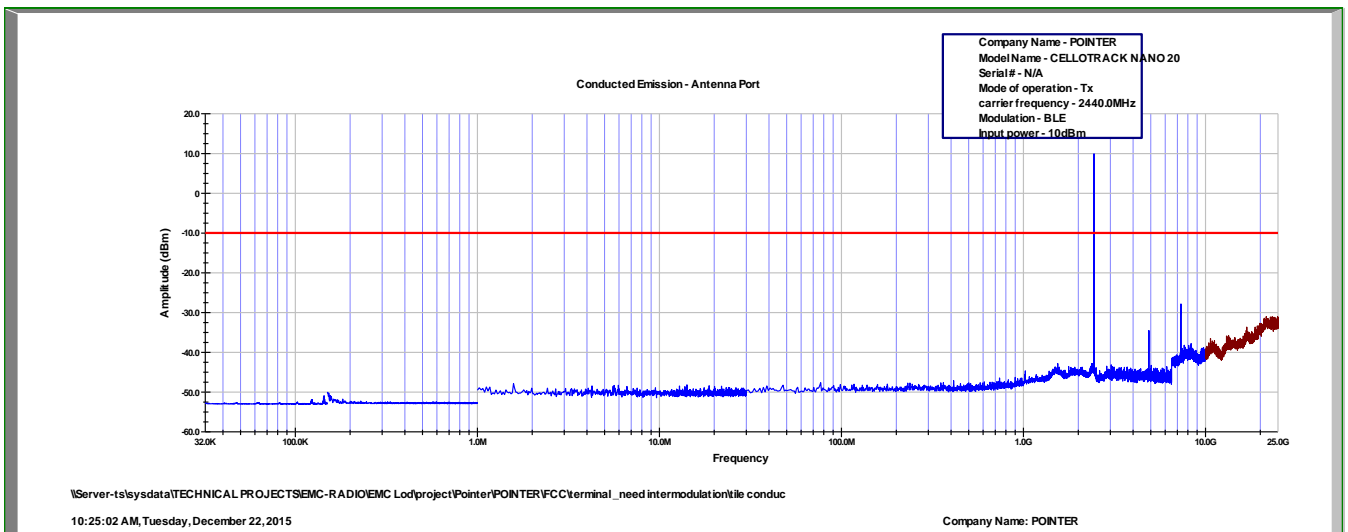

Figure 30 Fundamental 2440.0MHz

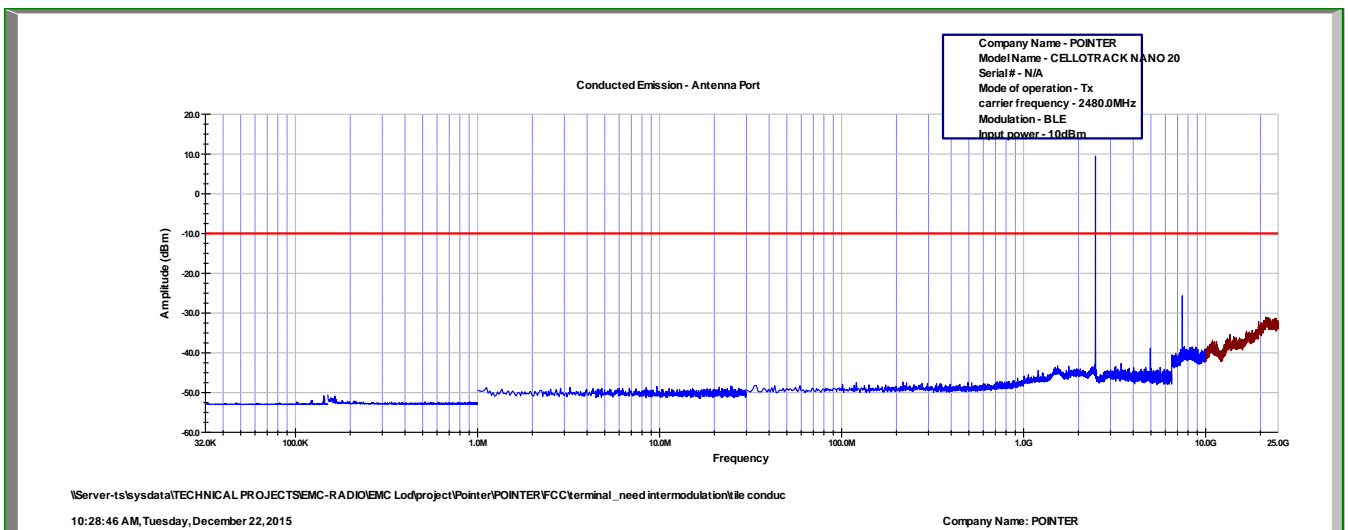

Figure 31 Fundamental 2480.0MHz



8.4 Test Instrumentation Used, Emission in Non Restricted Frequency Bands

Instrument	Manufacturer	Model	Serial No.	Last Calibration Date	Next Calibration Due
Spectrum Analyzer	HP	8592L	3826A01204	March 4, 2015	March 3, 2016
30 dB Attenuator	Bird	8304-N30DB	-	June 2, 2015	June 30, 2016

Figure 32 Test Equipment Used

9. Emissions in Restricted Frequency Bands

9.1 Test Specification

FCC, Part 15, Subpart C, Sections 15.209, 15.205, 15.247(d)
RSS GEN, Issue 4: 2014, Clause 8.9; 8.10

9.2 Test Procedure

For 9.0 kHz-1000.0MHz range:

A preliminary measurement to characterize the E.U.T was performed inside the shielded room at a distance of 3 meters, using peak detection mode and loop/broadband antennas. The preliminary measurements produced a list of the highest emissions. The E.U.T was then transferred to the open site, and placed on a remote-controlled turntable. The E.U.T was placed on a non-metallic table, 0.8 meters above the ground. The configuration tested is shown in *Figure 3*.

The frequency range of 9.0 kHz-1000.0MHz was scanned.

The emissions were measured using a computerized EMI receiver complying with CISPR 16 requirements.

In the frequency range of 9.0 kHz-30MHz, the center of the loop antenna height was one meter above the ground.

In the frequency range of 30MHz-1000MHz, the readings were maximized by adjusting the antenna height between 1-4 meters, the turntable azimuth between 0-360°, and the antenna polarization.

For 1000MHz-25000MHz range:

The E.U.T was placed in the chamber and placed on a remote-controlled turntable. The E.U.T was placed on a non-metallic table, 1.5 meters above the ground. The configuration tested is shown in *Figure 3*.

The frequency range 1000 MHz-25000 MHz was scanned.

The readings were maximized by adjusting the turntable azimuth between 0-360°, and the antenna polarization.

During average measurements, the IF bandwidth was 1 MHz and the video bandwidth was 100Hz. During peak measurements, the IF bandwidth was 1 MHz and the video bandwidth was 3 MHz.

In the frequency range 1000MHz-7000MHz, a computerized EMI receiver complying with CISPR 16 requirements was used.

In the frequency range 7000MHz-25000 MHz, a spectrum analyzer including a low noise amplifier was used.

For all final evaluations, the distance was 3 meters.

The E.U.T. was operated at the low, mid and high channels.
(2402, 2440, 2480 MHz).

The levels of the emissions within the frequency ranges of the restricted bands (Section 15.205 of FCC Part 15) were compared to the limits of the table in Section 15.209 (a), General Requirements.

Radiated emissions which fall in the restricted bands, as defined in §15.205(a), must also comply with the radiated emission limits specified in §15.209(a) (see §15.205(c)).

Frequency (MHz)	Field strength (microvolts/meter)	Measurement distance (meters)	Field strength* (dB μ V/m)	Field strength* (dB μ V/m)@3m
0.009-0.490	2400/F(kHz)	300	48.5-13.8	128.5-73.8
0.490-1.705	24000/F(kHz)	30	33.8-23.0	73.8-63.0
1.705-30.0	30	30	29.5	69.5
30-88	100	3	40.0	40.0
88-216	150	3	43.5	43.5
216-960	200	3	46.0	46.0
Above 960	500	3	54.0	54.0

*The emission limits shown in the above table are based on measurements employing a CISPR quasi-peak detector except for the frequency bands 9-90 kHz, 110-490 kHz and above 1000 MHz. Radiated emission limits in these three bands are based on measurements employing an average detector. For average radiated emission measurements above 1000 MHz, there is also a limit corresponding to 20 dB above the indicated values in the table is specified when measuring with peak detector function.

Figure 33 Table of Limits

9.3 Test Results

JUDGEMENT: Passed by 0.2 dB

For the operation frequency of 2402 MHz, the margin between the emission level and the specification limit is in the worst case 3.5 dB at the frequency of 2390.0 MHz, vertical and horizontal polarization.

For the operation frequency of 2440 MHz, the margin between the emission level and the specification limit is in the worst case 12.2 dB at the frequency of 4880.0 MHz, vertical polarization.

For the operation frequency of 2480 MHz, the margin between the emission level and the specification limit is in the worst case 0.2 dB at the frequency of 2483.5 MHz, vertical polarization.

The EUT met the requirements of the F.C.C. Part 15, Subpart C specification.

The details of the highest emissions are given in *Figure 34* to *Figure 35*.



Radiated Emission

E.U.T Description Self Powered Smart Hub
 Type CelloTrack Nano 20 P/N
 GC9770001-000
 Serial Number: Not designated

Specification: FCC, Part 15, Subpart C

Antenna Polarization: Horizontal/Vertical Frequency range: 9KHz to 25.0 GHz
 Test Distance: 3 meters Detector: Peak

Operation Frequency	Freq.	Polarity	Peak Reading	Peak. Specification	Peak. Margin
(MHz)	(MHz)	(H/V)	(dB μ V/m)	(dB μ V/m)	(dB)
2402.0	2390.0	H	62.5	74.0	-11.5
2402.0	2390.0	V	62.7	74.0	-11.3
2402.0	4804.0	H	50.1	74.0	-23.9
2402.0	4804.0	V	50.5	74.0	-23.5
2440.0	4880.0	H	52.1	74.0	-21.9
2440.0	4880.0	V	52.5	74.0	-21.5
2480.0	4960.0	H	48.9	74.0	-25.1
2480.0	4960.0	V	50.2	74.0	-23.8
2480.0	2483.5	H	62.2	74.0	-11.8
2480.0	2483.5	V	67.2	74.0	-6.8

Figure 34. Radiated Emission. Antenna Polarization: HORIZONTAL / VERTICAL. Detector: Peak

Margin refers to the test results obtained minus specified requirement; thus a positive number indicates failure, and a negative result indicates that the product passes the test.

“Peak Amp” includes correction factor.

* “Correction Factor” = Antenna Factor + Cable Loss- Low Noise Amplifier Gain



Radiated Emission

E.U.T Description Self Powered Smart Hub
Type CelloTrack Nano 20 P/N
GC9770001-000
Serial Number: Not designated

Specification: FCC, Part 15, Subpart C

Antenna Polarization: Horizontal/Vertical
Test Distance: 3 meters

Frequency range: 9KHz to 25.0 GHz
Detector: Average

Operation Frequency	Freq.	Polarity	Average Reading	Average Specification	Average Margin
(MHz)	(MHz)	(H/V)	(dB μ V/m)	(dB μ V/m)	(dB)
2402.0	2390.0	H	50.5	54.0	-3.5
2402.0	2390.0	V	50.5	54.0	-3.5
2402.0	4804.0	H	40.1	54.0	-13.9
2402.0	4804.0	V	40.9	54.0	-13.1
2440.0	4880.0	H	41.5	54.0	-12.5
2440.0	4880.0	V	41.8	54.0	-12.2
2480.0	4960.0	H	38.5	54.0	-15.5
2480.0	4960.0	V	38.4	54.0	-15.5
2480.0	2483.5	H	53.4	54.0	-0.6
2480.0	2483.5	V	53.5	54.0	-0.5

Figure 35. Radiated Emission. Antenna Polarization: HORIZONTAL / VERTICAL. Detector: Average

Notes:

Margin refers to the test results obtained minus specified requirement; thus a positive number indicates failure, and a negative result indicates that the product passes the test.

“Average Amp” includes correction factor.

* Correction Factor = Antenna Factor + Cable Loss- Low Noise Amplifier Gain



9.4 Test Instrumentation Used; Emissions in Restricted Frequency Bands

Instrument	Manufacturer	Model	Serial No.	Last Calibration Date	Next Calibration Due
EMI Receiver	R&S	ESCI7	100724	January 4, 2015	January 31, 2016
Spectrum Analyzer	HP	8592L	3826A01204	March 4, 2015	March 3, 2016
EMI Receiver	HP	8542E	3906A00276	March 11, 2015	March 31, 2016
RF Filter Section	HP	85420E	3705A00248	March 19, 2015	March 31, 2016
Spectrum Analyzer	HP	8564E	3442A00275	March 11, 2015	March 31, 2016
Biconical Antenna	EMCO	3104	2606	December 28, 2014	December 28, 2015
Log Periodic Antenna	EMCO	3146	9505-4081	December 28, 2014	December 28, 2015
Horn Antenna	ETS	3115	29845	May 19, 2015	May 19, 2018
Horn Antenna	ARA	SWH-28	1007	March 3, 2014	March 30, 2016
Active Loop Antenna	EMCO	6502	9506-2950	November 4, 2015	November 30, 2016
Low Noise Amplifier	Narda	DBS-0411N313	13	March 1, 2015	March 1, 2016
Low Noise Amplifier	Sophia Wireless	LNA28-B	232	March 1, 2015	March 1, 2016
Spectrum Analyzer	HP	8593EM	3536A00120 ADI	February 24, 2015	February 28, 2016
Semi Anechoic Civil Chamber	ETS	S81	SL 11643	N/A	N/A
Antenna Mast	ETS	2070-2	9608-1497	N/A	N/A
Turntable	ETS	2087	-	N/A	N/A
Mast & Table Controller	ETS/EMCO	2090	9608-1456	N/A	N/A

Figure 36 Test Equipment Used

10. Transmitted Power Density

10.1 Test Specification

FCC, Part 15, Subpart C, Section 247(e)
RSS-247, Issue 1:2015, Clause 5.2(2)

10.2 Test Procedure

The E.U.T operation mode and test set-up are as described in Section 2 of this report.

The E.U.T. antenna terminal was connected to the Spectrum Analyzer through an external attenuator and an appropriate coaxial cable (loss=20.5 dB). Special attention was taken to prevent Spectrum Analyzer RF input overload.

The spectrum analyzer was set to 3 kHz RBW and VBW to 10 kHz.

The E.U.T was evaluated in 3 channels: Low (2402.0MHz), Mid (2440.0MHz) and High (2480.0MHz).

10.3 Test Results

Operation Frequency (MHz)	Reading Spectrum Analyzer (dBm)	Antenna gain (dBi)	Total PSD (dBm)	Specification (dBm)	Margin (dB)
2402.0	-9.4	1.7	-7.7	8.0	-15.7
2440.0	-9.1	1.7	-7.4	8.0	-15.4
2480.0	-9.2	1.7	-7.5	8.0	-15.5

Figure 37 Test Results

JUDGEMENT: Passed by 15.4 dB

For additional information see *Figure 38* to *Figure 40*.

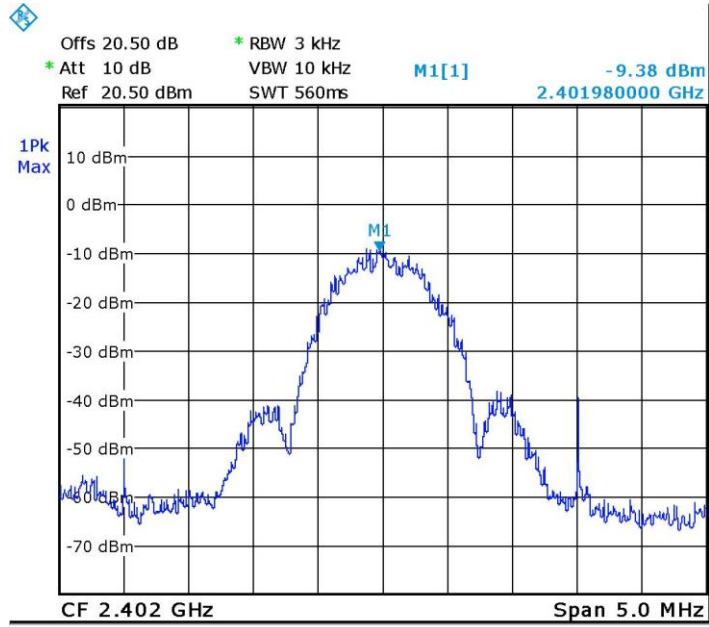

Date: 21.DEC.2015 15:35:46

Figure 38 — 2402.0 MHz

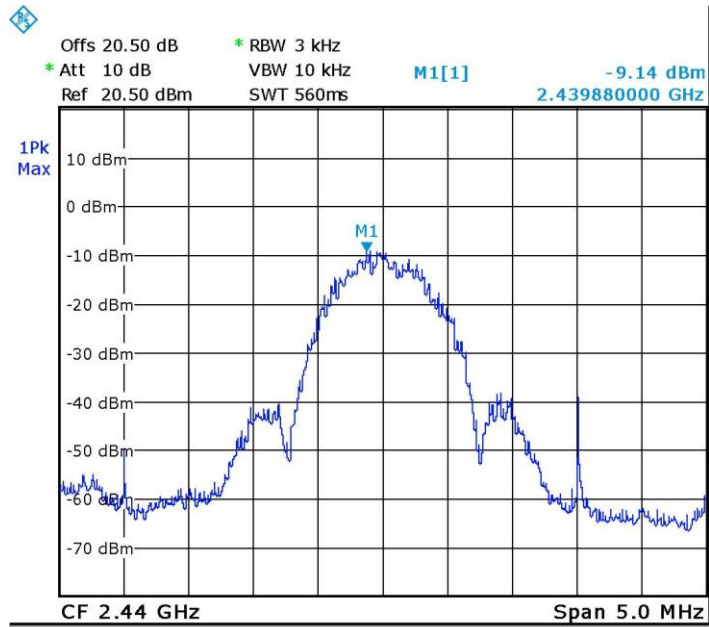

Date: 21.DEC.2015 15:35:31

Figure 39 — 2440.0 MHz

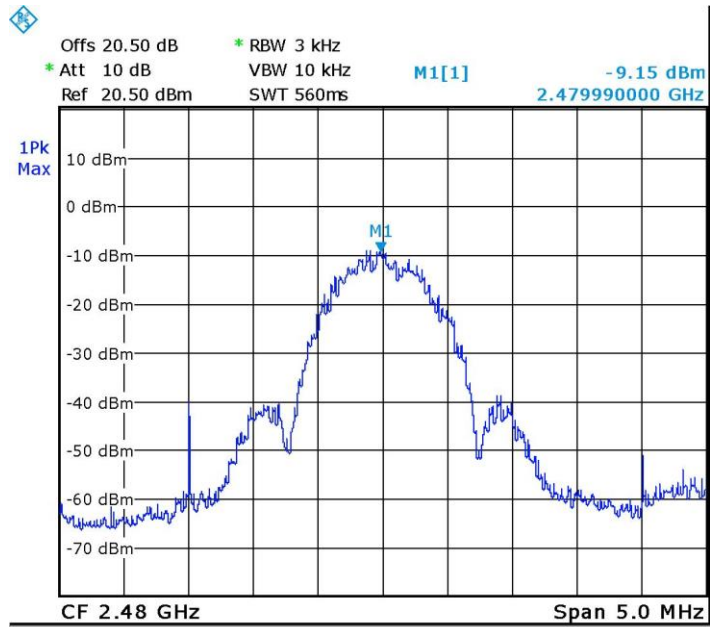

Date: 21.DEC.2015 15:35:11

Figure 40 — 2480.0 MHz



10.4 Test Equipment Used; Transmitted Power Density

Instrument	Manufacturer	Model	Serial No.	Last Calibration Date	Next Calibration Due
Spectrum Analyzer	R&S	FSL6	100194	January 1, 2015	January 31, 2016
20 dB Attenuator	MCL	VAT-20W2+	848	June 15, 2015	June 30, 2016

Figure 41 Test Equipment Used

11. Intermodulation Radiated Spurious Emissions

11.1 Test Procedure

For 9.0 kHz-1000.0MHz range:

A preliminary measurement to characterize the E.U.T was performed inside the shielded room at a distance of 3 meters, using peak detection mode and broadband antennas. The preliminary measurements produced a list of the highest emissions. The E.U.T was then transferred to the open site, and placed on a remote-controlled turntable. The E.U.T was placed on a non-metallic table, 0.8 meters above the ground. The configuration tested is shown in *Figure 3*.

The frequency range of 9.0 kHz-1000.0MHz was scanned.

The emissions were measured using a computerized EMI receiver complying with CISPR 16 requirements.

In the frequency range of 9.0 kHz-30MHz, the center of the loop antenna height was one meter above the ground.

In the frequency range of 30MHz-1000MHz, the readings were maximized by adjusting the antenna height between 1-4 meters, the turntable azimuth between 0-360°, and the antenna polarization.

For 1000MHz-25000MHz range:

The E.U.T was placed in the chamber and placed on a remote-controlled turntable. The E.U.T was placed on a non-metallic table, 1.5 meters above the ground. The configuration tested is shown in *Figure 3*.

The frequency range 1000 MHz-25000 MHz was scanned.

The readings were maximized by adjusting the turntable azimuth between 0-360°, and the antenna polarization.

During average measurements, the IF bandwidth was 1 MHz and the video bandwidth was 100Hz. During peak measurements, the IF bandwidth was 1 MHz and the video bandwidth was 3 MHz.

In the frequency range 1000-7000MHz, a computerized EMI receiver complying with CISPR 16 requirements was used.

In the frequency range 7000 MHz-25000 MHz, a spectrum analyzer including a low noise amplifier was used.

For all final evaluations, the distance was 3 meters.

The E.U.T. was operated simultaneously at the low BLE channel (2402MHz) and low channel for the closed cellular band (2G/3G).

The levels of the emissions within the frequency ranges of the restricted bands (Section 15.205 of FCC Part 15) were compared to the limits of the table in Section 15.209 (a), General Requirements.

Radiated emissions which fall in the restricted bands, as defined in §15.205(a), must also comply with the radiated emission limits specified in §15.209(a) (see §15.205(c)).



Frequency (MHz)	Field strength (microvolts/meter)	Measurement distance (meters)	Field strength* (dB μ V/m)	Field strength* (dB μ V/m)@3m
0.009-0.490	2400/F(kHz)	300	48.5-13.8	128.5-73.8
0.490-1.705	24000/F(kHz)	30	33.8-23.0	73.8-63.0
1.705-30.0	30	30	29.5	69.5
30-88	100	3	40.0	40.0
88-216	150	3	43.5	43.5
216-960	200	3	46.0	46.0
Above 960	500	3	54.0	54.0

*The emission limits shown in the above table are based on measurements employing a CISPR quasi-peak detector except for the frequency bands 9-90 kHz, 110-490 kHz and above 1000 MHz. Radiated emission limits in these three bands are based on measurements employing an average detector. For average radiated emission measurements above 1000 MHz, there is also a limit corresponding to 20 dB above the indicated values in the table is specified when measuring with peak detector function.

Figure 42 Table of Limits



11.2 Test Results

JUDGEMENT: Passed

Freq.	Polarity	Peak Reading	Average Reading	Peak Specification	Average Specification	Peak Margin	Average Margin
(MHz)	(H/V)	(dB μ V/m)	(dB μ V/m)	(dB μ V/m)	(dB μ V/m)	(dB)	(dB)
3019.2	H	60.8	52.0	74.0	54.0	-13.2	-2.0
	V	60.2	51.4	74.0	54.0	-13.8	-2.6
1167.6	H	49.6	41.6	74.0	54.0	-24.4	-12.4
	V	57.2	53.8	74.0	54.0	-16.8	-0.2
3636.4	H	59.8	51.3	74.0	54.0	-14.2	-2.7
	V	60.1	51.4	74.0	54.0	-13.9	-2.6

Figure 43 2G unit Intermodulation Radiated Results (2G and BT)



**11.3 Test Instrumentation Used; Radiated Measurements
Intermodulation**

Instrument	Manufacturer	Model	Serial No.	Last Calibration Date	Next Calibration Due
EMI Receiver	R&S	ESCI7	100724	January 4, 2015	January 31, 2016
Spectrum Analyzer	HP	8592L	3826A01204	March 4, 2015	March 3, 2016
EMI Receiver	HP	8542E	3906A00276	March 11, 2015	March 31, 2016
RF Filter Section	HP	85420E	3705A00248	March 19, 2015	March 31, 2016
Spectrum Analyzer	HP	8564E	3442A00275	March 11, 2015	March 31, 2016
Biconical Antenna	EMCO	3104	2606	December 28, 2014	December 28, 2015
Log Periodic Antenna	EMCO	3146	9505-4081	December 28, 2014	December 28, 2015
Horn Antenna	ETS	3115	29845	May 19, 2015	May 19, 2018
Horn Antenna	ARA	SWH-28	1007	March 3, 2014	March 30, 2016
Active Loop Antenna	EMCO	6502	9506-2950	November 4, 2015	November 30, 2016
Low Noise Amplifier	Narda	DBS-0411N313	13	March 1, 2015	March 1, 2016
Low Noise Amplifier	Sophia Wireless	LNA28-B	232	March 1, 2015	March 1, 2016
Spectrum Analyzer	HP	8593EM	3536A00120 ADI	February 24, 2015	February 28, 2016
Semi Anechoic Civil Chamber	ETS	S81	SL 11643	N/A	N/A
Antenna Mast	ETS	2070-2	9608-1497	N/A	N/A
Turntable	ETS	2087	-	N/A	N/A
Mast & Table Controller	ETS/EMCO	2090	9608-1456	N/A	N/A

Figure 44 Test Equipment Used



12. Antenna Gain/Information

The antenna gain is 1.7 dBi, integral.

13. APPENDIX A - CORRECTION FACTORS

13.1 *Correction factors for CABLE from EMI receiver to test antenna at 3 meter range.*

Frequency (MHz)	Cable Loss (dB)
0.010	0.4
0.015	0.2
0.020	0.2
0.030	0.3
0.050	0.3
0.075	0.3
0.100	0.2
0.150	0.2
0.200	0.3
0.500	0.4
1.00	0.4
1.50	0.5
2.00	0.5
5.00	0.6
10.00	0.8
15.00	0.9
20.00	0.8

Frequency (MHz)	Cable Loss (dB)
50.00	1.2
100.00	0.7
150.00	2.1
200.00	2.3
300.00	2.9
500.00	3.8
750.00	4.8
1000.00	5.4
1500.00	6.7
2000.00	9.0
2500.00	9.4
3000.00	9.9
3500.00	10.2
4000.00	11.2
4500.00	12.1
5000.00	13.1
5500.00	13.5
6000.00	14.5

NOTES:

1. The cable type is SPUMA400 RF-11N(X2) and 39m long
2. The cable is manufactured by Huber + Suhner



13.2 Correction factor for RF CABLE for Semi Anechoic Chamber

FREQ (MHz)	LOSS (dB)
1000.0	1.5
2000.0	2.1
3000.0	2.7
4000.0	3.1
5000.0	3.5
6000.0	4.1
7000.0	4.6
8000.0	4.9
9000.0	5.7
10000.0	5.7
11000.0	6.1
12000.0	6.1
13000.0	6.2
14000.0	6.7
15000.0	7.4
16000.0	7.5
17000.0	7.9
18000.0	8.1
19000.0	8.8
20000.0	9.1

NOTES:

- 1. The cable is manufactured by Commscope*
- 2. The cable type is 0623 WBC-400, serial # G020132 and 10m long*
- 3. ITL # 1840*



13.3 Correction factors for Low Loss CABLE
Huber Suner #1696
Serial No. 705A009301 EIM

FREQ (MHz)	INPUT (dBm)	OUTPUT (dBm)	LOSS (dB)
1000.0	-10	-10.7	0.7
2000.0	-10	-10.7	0.7
3000.0	-10	-10.6	0.6
4000.0	-10	-10.5	0.5
5000.0	-10	-10.7	0.7
6000.0	-10	-10.8	0.8
7000.0	-10	-10.8	0.8
8000.0	-10	-11.0	1.0
9000.0	-10	-10.5	0.5
10000.0	-10	-10.3	0.3
11000.0	-10	-10.5	0.5
12000.0	-10	-11.3	1.3
13000.0	-10	-11.6	1.6
14000.0	-10	-11.8	1.8
15000.0	-10	-11.0	1.0
16000.0	-10	-10.6	0.6
17000.0	-10	-12.0	2.0
18000.0	-10	-11.6	1.6



13.4 Correction factors for

**Horn Antenna
Model: SWH-28
at 1 meter range.**

FREQUENCY (GHz)	AFE (dB /m)	Gain (dB1)
18.0	40.3	16.1
19.0	40.3	16.3
20.0	40.3	16.1
21.0	40.3	16.3
22.0	40.4	16.8
23.0	40.5	16.4
24.0	40.5	16.6
25.0	40.5	16.7
26.0	40.6	16.4



13.5 Correction factors for

Horn ANTENNA.

Model: 3115

Antenna serial number: 29845

10 meter range

FREQUENCY	AFE	FREQUENCY	AFE
(MHz)	(dB/m)	(MHz)	(dB/m)
1000	22.4	10000	36.1
2000	25.2	11000	37.0
3000	31.1	12000	41.3
4000	30.2	13000	38.1
5000	34.2	14000	41.7
6000	31.6	15000	39.0
7000	34.7	16000	38.8
8000	34.8	17000	43.2
9000	36.2	18000	43.7



**13.6 Correction factors for Log Periodic Antenna
EMCO, Model 3146,
Serial #9505-4081**

CALIBRATION DATA

Frequency, MHz	Antenna factor, dB/m ¹⁾
200	11.55
250	11.60
300	14.43
400	15.38
500	17.98
600	18.78
700	21.17
800	21.16
900	22.67
1000	24.09

¹⁾ The antenna factor shall be added to receiver reading in dB μ V to obtain field strength in dB μ V/m.



13.7 Correction factors for ACTIVE LOOP ANTENNA

**Model 6502
S/N 9506-2950**

FREQUENCY	Magnetic Antenna Factor	Electric Antenna Factor
(MHz)	(dB)	(dB)
.009	-35.1	16.4
.010	-35.7	15.8
.020	-38.5	13.0
.050	-39.6	11.9
.075	-39.8	11.8
.100	-40.0	11.6
.150	-40.0	11.5
.250	-40.0	11.6
.500	-40.0	11.5
.750	-40.1	11.5
1.000	-39.9	11.7
2.000	-39.5	12.0
3.000	-39.4	12.1
4.000	-39.7	11.9
5.000	-39.7	11.8
10.000	40.2	11.3
15.000	-40.7	10.8
20.000	-40.5	11.0
25.000	-41.3	10.2
30.000	42.3	9.2



**13.8 Correction factors for Biconical Antenna
EMCO, Model 3104,
Serial #2606**

CALIBRATION DATA

Frequency, MHz	Near free space antenna factor, dB/m	Geometry specific correction factor, dB	Free space antenna factor, dB/m ¹⁾
30	12.97	0.13	12.84
35	12.34	0.09	12.25
40	12.03	0.06	11.97
45	11.42	0.02	11.40
50	11.91	0.03	11.88
60	11.92	0.37	11.55
70	9.60	0.25	9.35
80	6.99	-0.45	7.44
90	10.87	-0.34	11.21
100	11.51	-0.06	11.57
120	13.30	0.20	13.10
140	12.56	-0.01	12.57
160	14.49	-0.12	14.61
180	16.53	0.05	16.48
200	15.30	0.15	15.15

¹⁾ The antenna factor shall be added to receiver reading in dB μ V to obtain field strength in dB μ V/m.